

3-2

응시번호
성명
감독확인
(서명)

2안

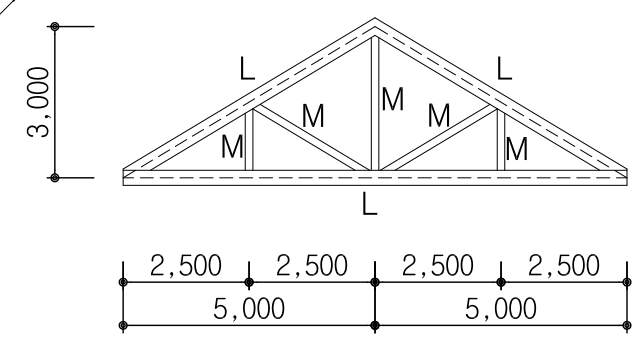

측면부 트러스 입면도
축척:1/150

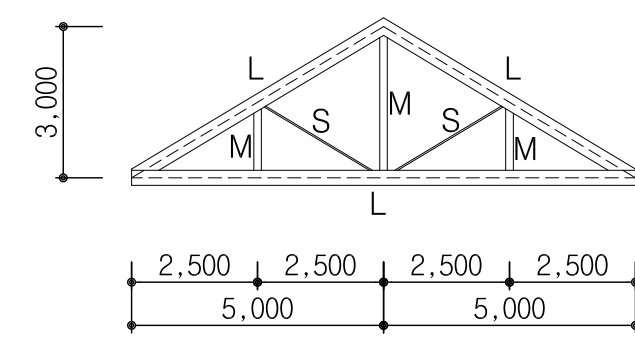

중간부 트러스 입면도
축척:1/150

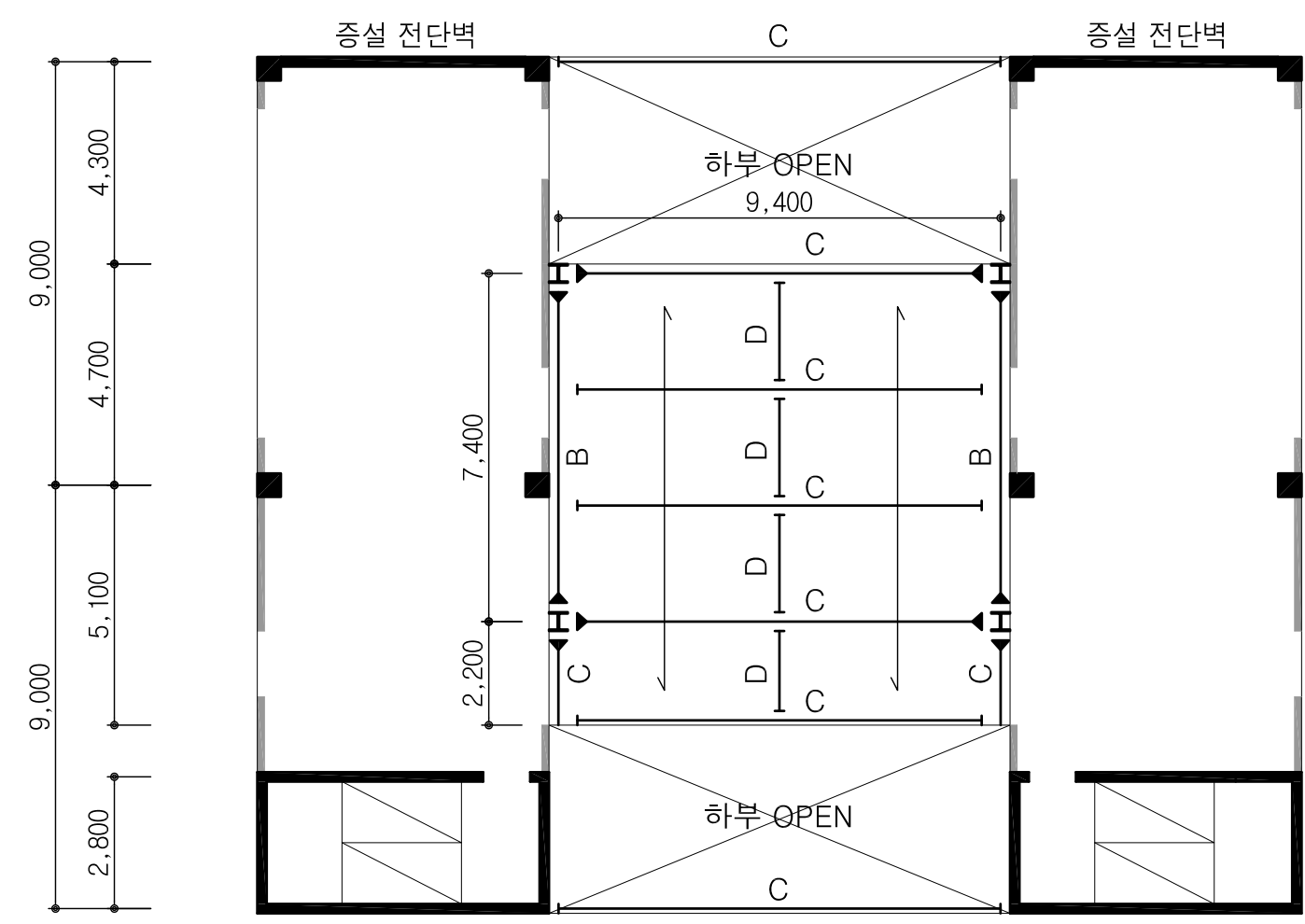
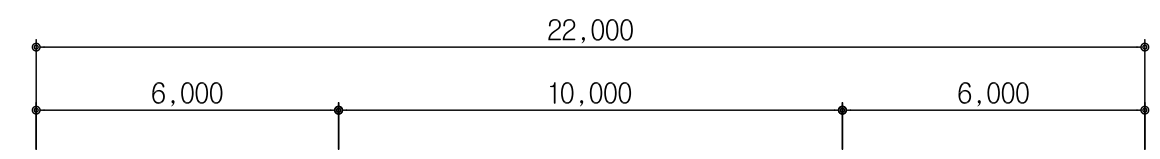
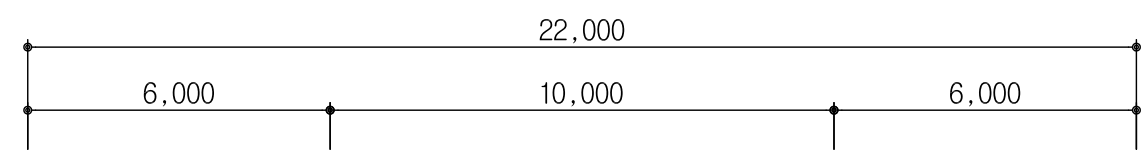

2층 구조평면도
축척:1/150

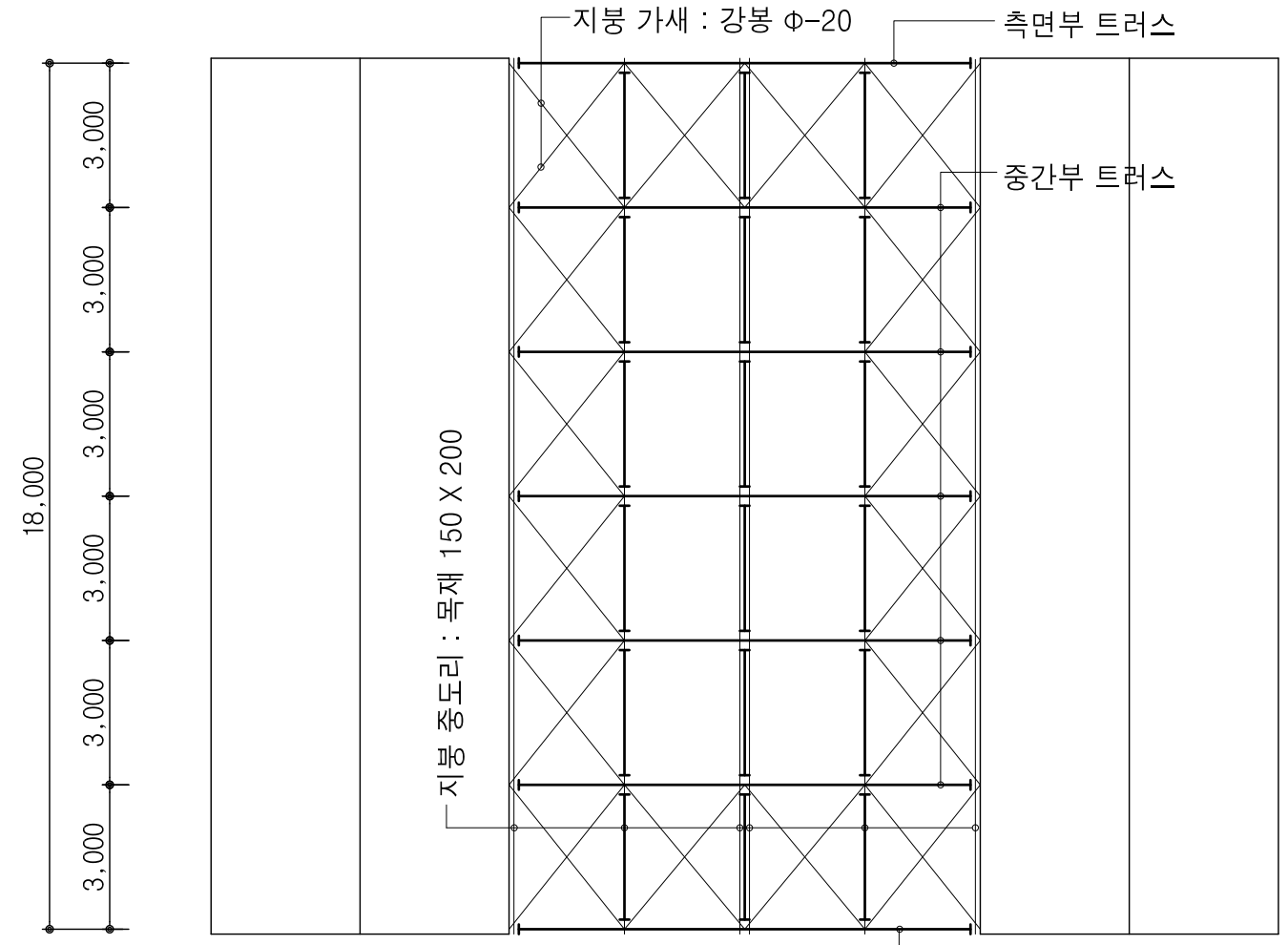

지붕 구조평면도
축척:1/150